



We are the only supplier of Commando & Dominator parts using the original factory drawings. Our products are mostly made in England and to original specification. We also offer Norton Rotary spares, factory service manuals and literature for **NORTON** and **TRIUMPH** motorcycles.

INSIST ON GENUINE FACTORY PARTS PACKAGED WITH THIS LOGO



NORTON COMMANDO PRIMARY SIDE including ELECTRIC START (850Mk3)

1

Currently not available

06.6023

2

06.7952

3

06.0355

4

06.4727

5

06.5956

6

06.4689

7

06.4691

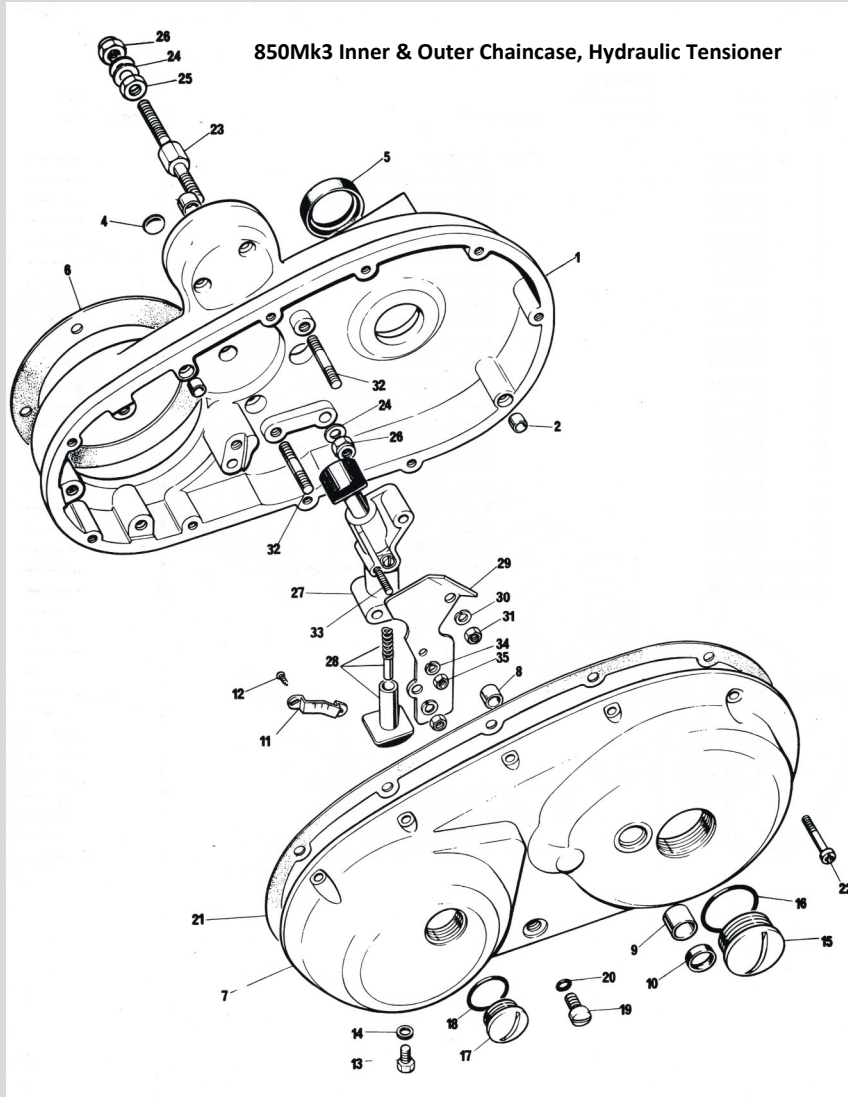

8

06.5185

9

06.6189

10

06.5181

11

06.4694

12

06.0787

13

14.0101

14

04.1123

15

06.0388

19

06.2582

16

06.2581

17

06.0659

18

06.2580

20

06.2583



We are the only supplier of Commando & Dominator parts using the original factory drawings. Our products are mostly made in England and to original specification. We also offer Norton Rotary spares, factory service manuals and literature for **NORTON** and **TRIUMPH** motorcycles.

INSIST ON GENUINE FACTORY PARTS PACKAGED WITH THIS LOGO



NORTON COMMANDO PRIMARY SIDE including ELECTRIC START (850Mk3)

850Mk3 Inner & Outer Chaincase, Hydraulic Tensioner

- 21: 06.5534 (Orange O-ring)
- 22: 06.5533 (Screw)
- 23: 06.6257 (Pin)
- 24: 60.2322 (Washer)
- 25: 14.0403 (Nut)
- 26: 06.0397 (Nut)
- 27: 06.4718 (Bracket)
- 28: 06.5341 (Bracket)
- 29: 06.6001 (Bracket)
- 30: 60.2418 (Washer)
- 31: 14.0302 (Nut)
- 32: 06.4717 (Pin)
- 33: 06.3189 (Wrench)
- 34: 60.2417 (Washer)



We are the only supplier of Commando & Dominator parts using the original factory drawings. Our products are mostly made in England and to original specification. We also offer Norton Rotary spares, factory service manuals and literature for **NORTON** and **TRIUMPH** motorcycles.

INSIST ON GENUINE FACTORY PARTS PACKAGED WITH THIS LOGO



NORTON COMMANDO PRIMARY SIDE including ELECTRIC START (850Mk3)

Gear Linkage, Chain, Alternator & Engine Sprocket

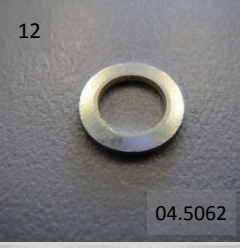
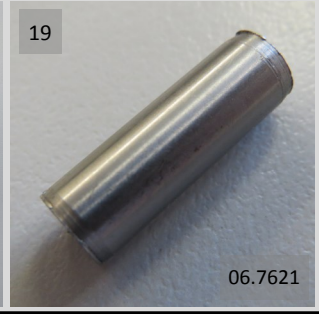
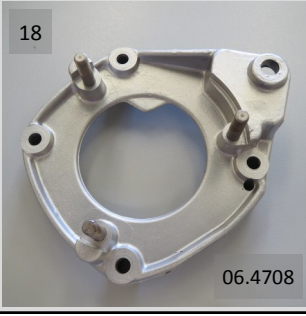
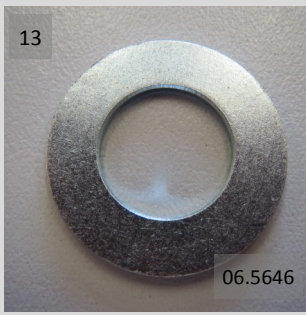
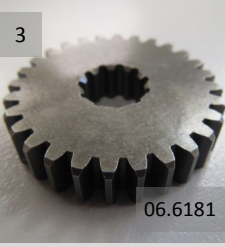
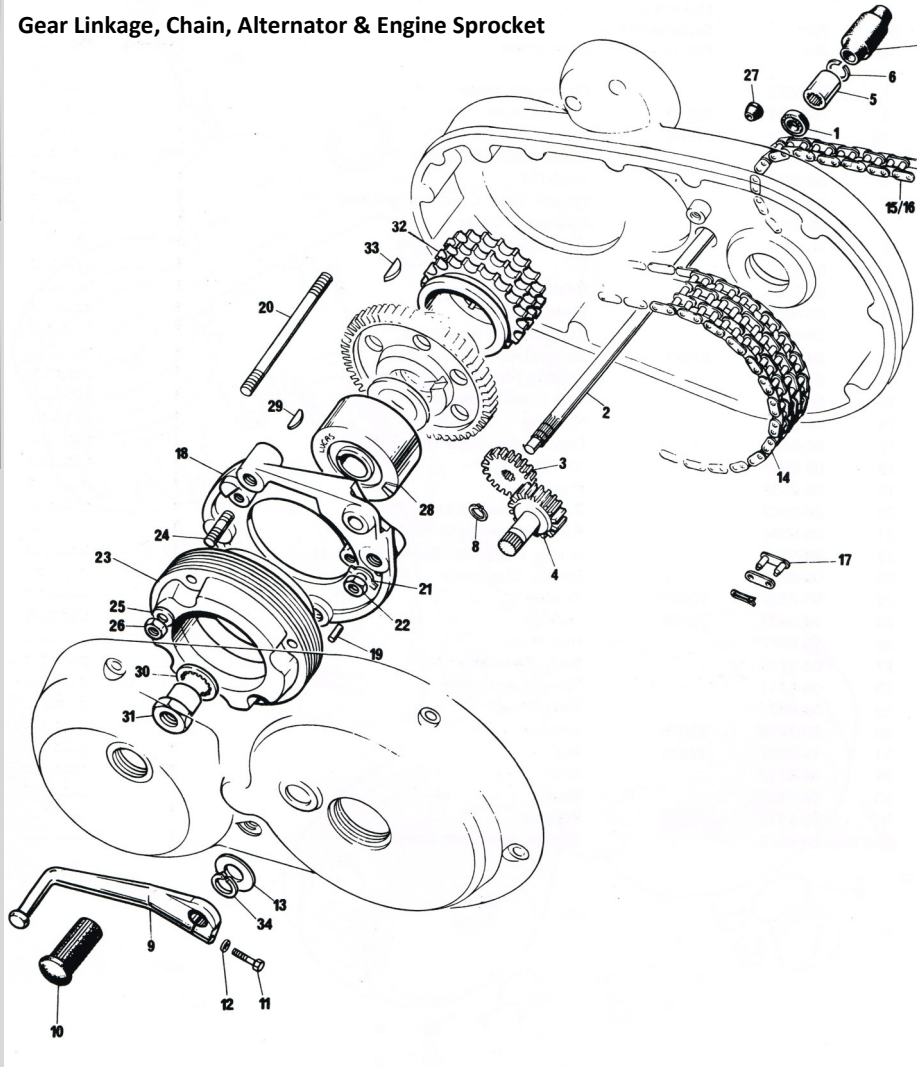



We are the only supplier of Commando & Dominator parts using the original factory drawings. Our products are mostly made in England and to original specification. We also offer Norton Rotary spares, factory service manuals and literature for **NORTON** and **TRIUMPH** motorcycles.

INSIST ON GENUINE FACTORY PARTS PACKAGED WITH THIS LOGO



NORTON COMMANDO PRIMARY SIDE including ELECTRIC START (850Mk3)

Gear Linkage, Chain, Alternator & Engine Sprocket

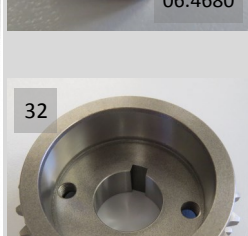
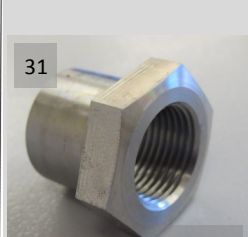
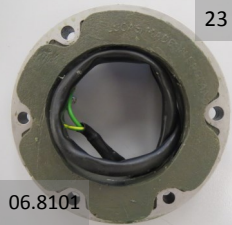
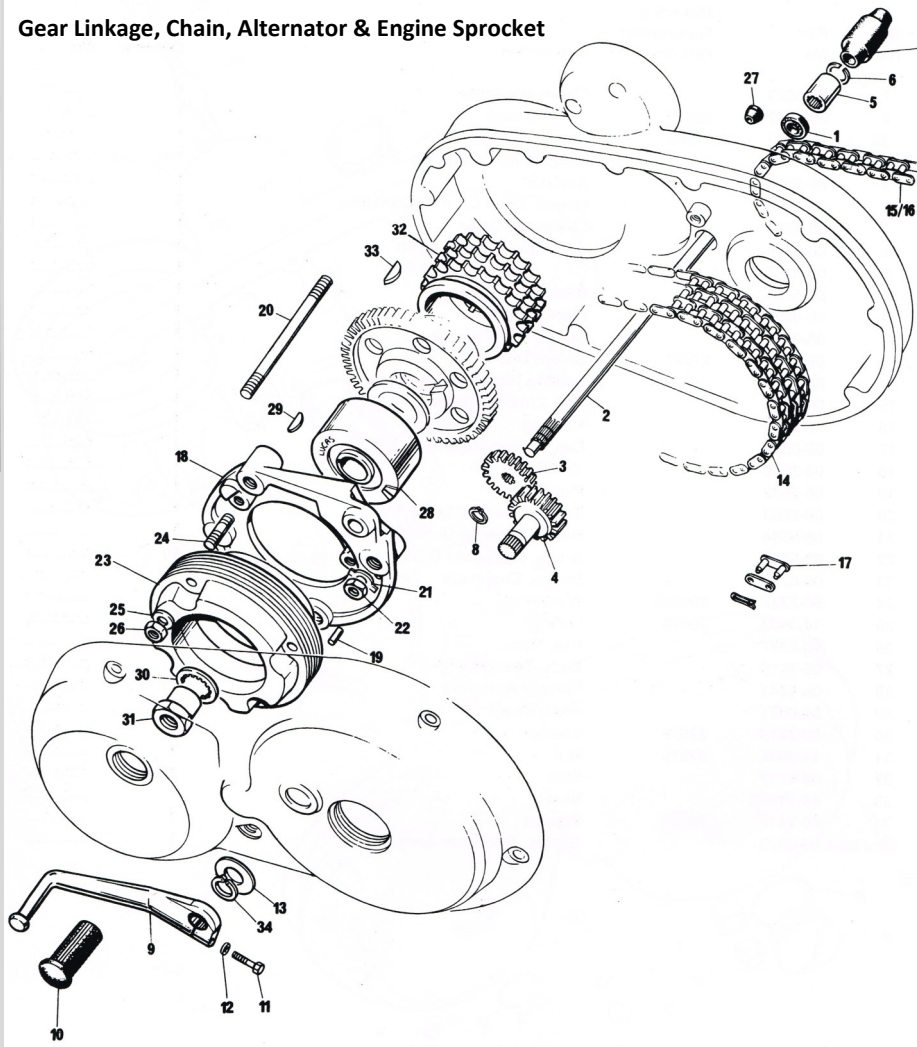





We are the only supplier of Commando & Dominator parts using the original factory drawings. Our products are mostly made in England and to original specification. We also offer Norton Rotary spares, factory service manuals and literature for **NORTON** and **TRIUMPH** motorcycles.

INSIST ON GENUINE FACTORY PARTS PACKAGED WITH THIS LOGO





NORTON COMMANDO PRIMARY SIDE including ELECTRIC START (850Mk3)

1  06.4704

2  06.4729

3  06.5532

4  06.4703

5  06.4702

6  06.4705

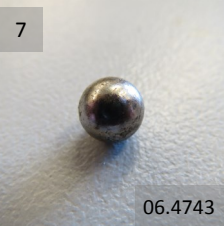
7  06.4743

Electric Start

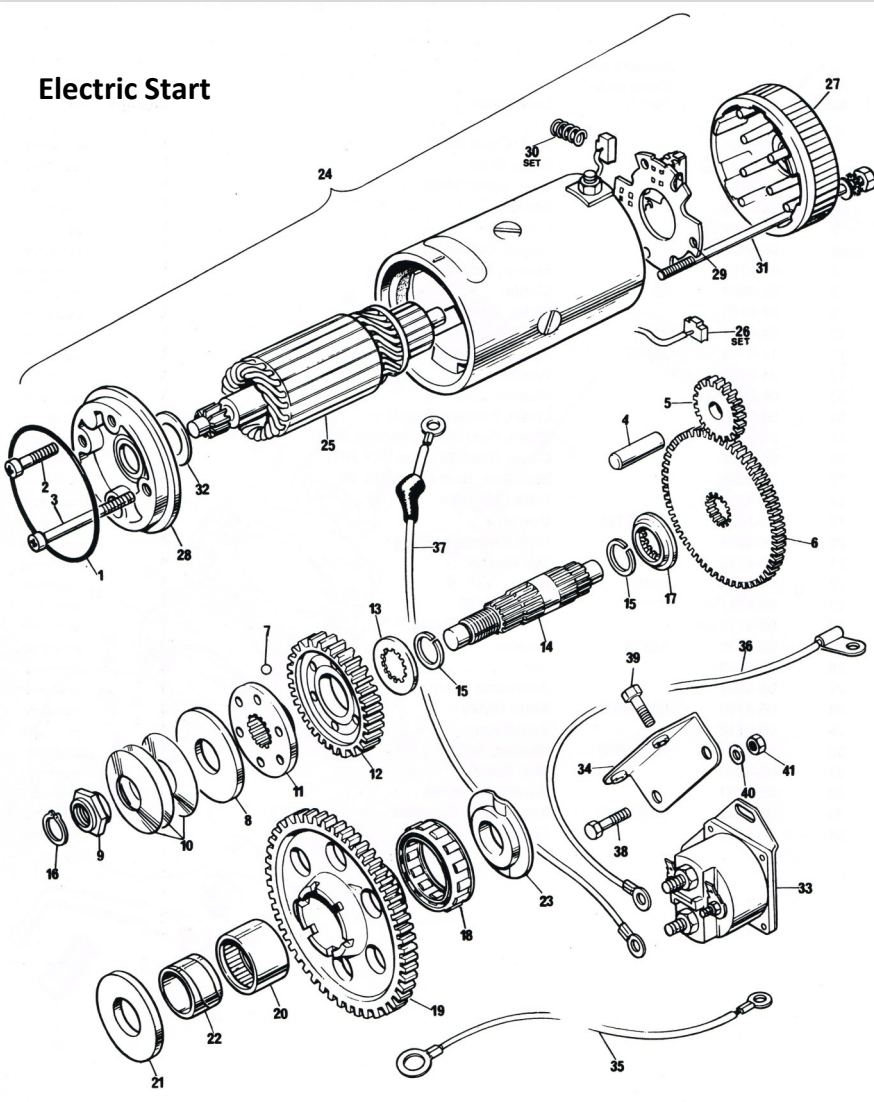



8  06.4741

9  06.4745

10  06.4740

11  06.4744

12  06.4707

13  06.5652

14  06.4706

15  06.8072

16  06.4754

17  06.5652

18  06.4733

19  06.4731

20  06.4711



We are the only supplier of Commando & Dominator parts using the original factory drawings. Our products are mostly made in England and to original specification. We also offer Norton Rotary spares, factory service manuals and literature for **NORTON** and **TRIUMPH** motorcycles.

INSIST ON GENUINE FACTORY PARTS PACKAGED WITH THIS LOGO



NORTON COMMANDO PRIMARY SIDE including ELECTRIC START (850Mk3)

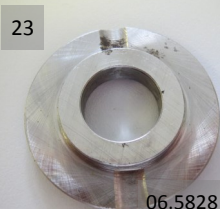

24 to 31
Currently not available

